



**METAL SUPPLY LLC**



[www.dxdsupply.com](http://www.dxdsupply.com)

# METAL BROCHURE

## COLORS

### RIB PANEL

This model is the most versatile and Economical of our line. Ideal for residential, commercial and agricultural applications.



**Panel Width: 36"** **Ribs: 3/4 Rib Space 9" on center** **Gauge: 26 or 29**

### R-PANEL

It is rigid metal panel, popular in commercial applications or where additional thickness/stiffness is needed.



**Panel Width: 36"** **Ribs: 1.3 Rib Space 12" on center** **Gauge: 26**

### 5-V CRIMP

Is a time-honored profile. It gets its name from its V-SHAPED ribs offering a noatalgic look for construction projects, new and old.



**Panel Width: 24"** **Ribs: 1/2" V Ribs Space 12" on center** **Gauge: 26 or 29**

### STANDING SEAM

This panel is perfect for historic renovation, as well new costruction.



**Panel Width: 16"** **Ribs: 1"** **Gauge: 26**

### 1" OR 1.5" SNAPLOOK STANDING SEAM

Designed to accent or cover high profile homes and buildings, Snaplook Standing Seam uses a concealed fastener system for a sleek, finished look. Clip and nailstrip systems are available for installation.

**Panel Width: 16"** **Ribs: N/A** **Gauge: 24 or 26**



EVERGREEN

RUSTIC RED

CHARCOAL GRAY

OLD TOWN GRAY

BURNISHED SLATE

COCOA BROWN

BLACK

POLAR WHITE

SADDLE TAN

DESERT SAND

IVORY

LIGHT STONE

HAWAIIAN BLUE

BERRY

GALVALUME

16oz COPPER

COPPER PENNY

ASH GRAY

FERN GRAY

GALLERY BLUE

# FLASHING PROFILES

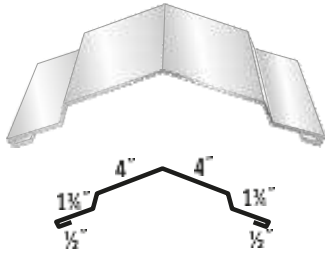

#1 (R) Universal Ridge Cap  
#1 (H) Universal Hip Cap

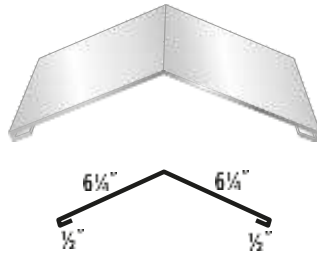

#2 (R) Standard Ridge Cap  
#2 (H) Standard Hip Cap

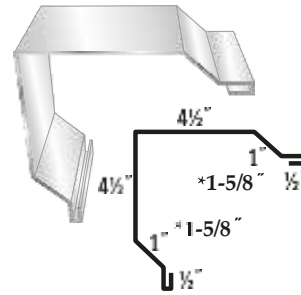

#3 Rake & Corner (AG)  
#78 Rake & Corner (\*PBR)

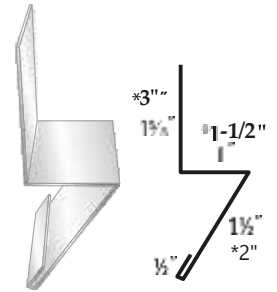

#4 Base Angle (AG)  
#5 Base Angle (\*PBR)

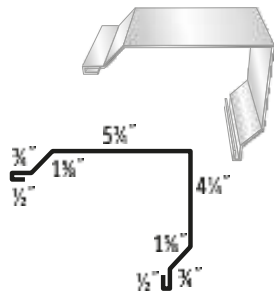

#7 Gable Trim

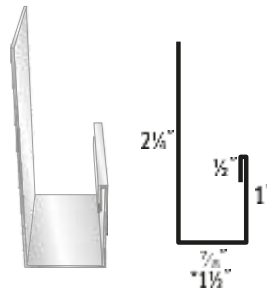

#8 "J" Trim (AG)  
#9 "J" Trim (\*PBR)

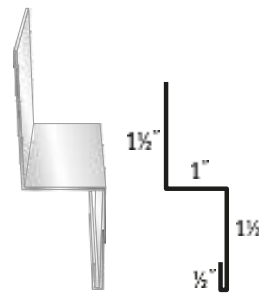

#10 Double Angle

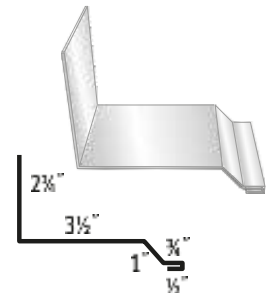

#11 Universal Sidewall

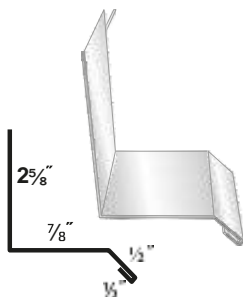

#12 Drip Cap (AG)

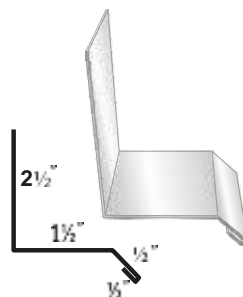

#13 Drip Cap (PBR)

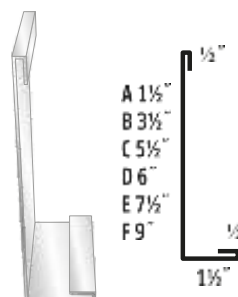

#14 Post Trim

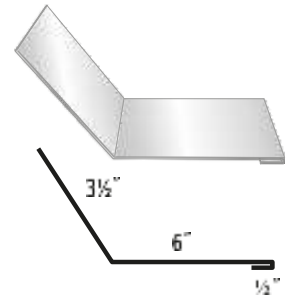

#15 Universal Endwall

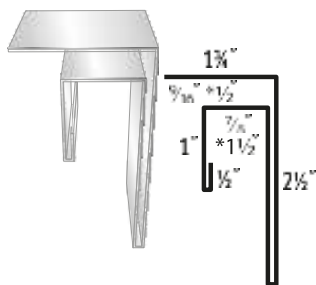

#16 "F" & "J" (AG)  
#17 "F" & "J" (\*PBR)

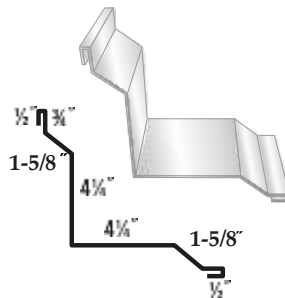

#18 Inside Corner

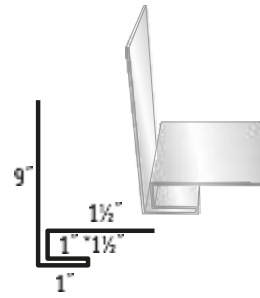

#19 Overhead Door Trim (AG)  
#20 Overhead Door Trim (\*PBR)

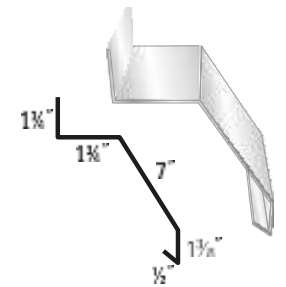

#21 Face Mount Cannon-cover

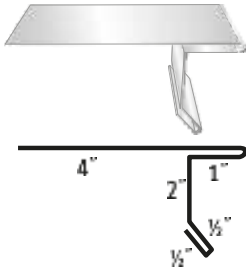

#22 'F' Trim

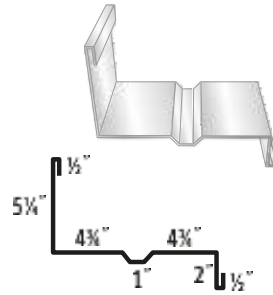

#23 One piece Fascia & Soffit

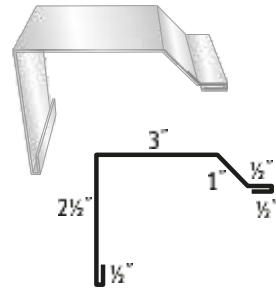

#24 Residential Rake

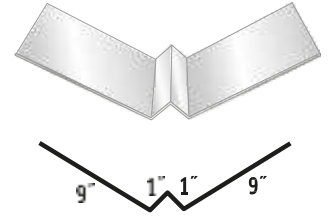

#25 Formed Valley

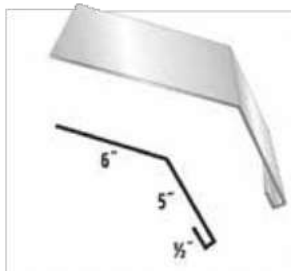

#27 Notched Gambrel

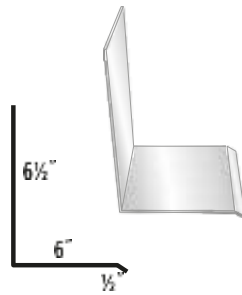

#28 'L' Flashing

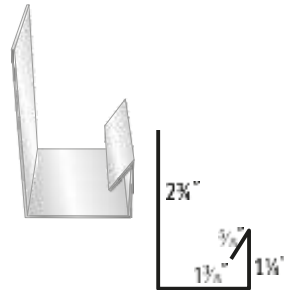

#29 Jamb Trim

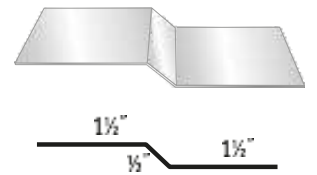

#30 Offset Cleat

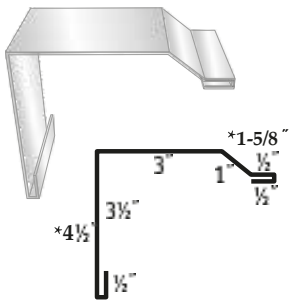

#31 Extended Rake (AG)  
#79 Extended Rake (\*PBR)

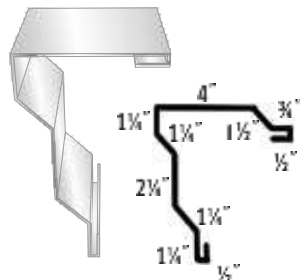

#32 Sculptured Rake

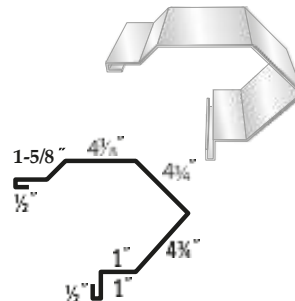

#33 Commercial Rake

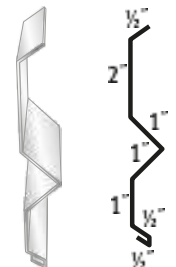

#34 Headwall Counter Flashing

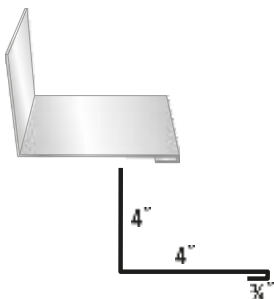

#37 SS Sidewall

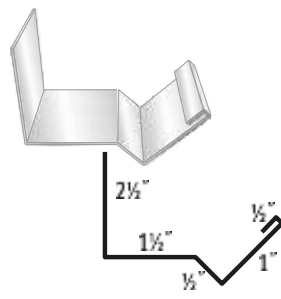

#38 Header Trim

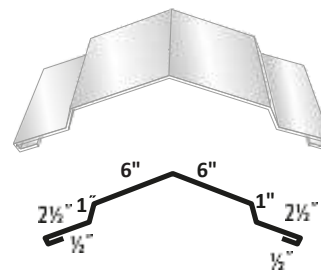

#39 XL Universal Ridge Cap

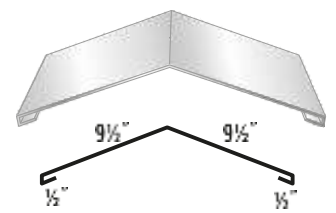

#40 XL Standard Ridge

# FLASHING PROFILES



#41 Stucco Stop

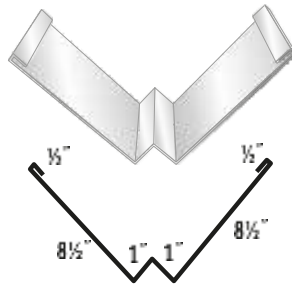

#42 SS Valley

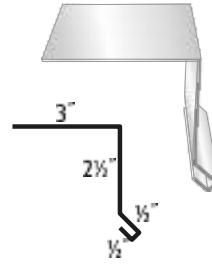

#44 Small Eave

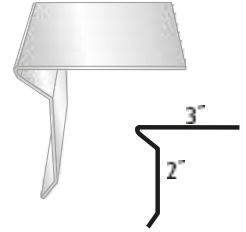

#45 Eave Trim



#47 Cleat

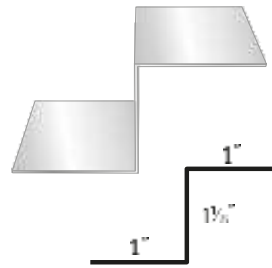

#48 Z Flashing

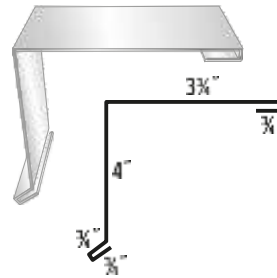

#49 Gable Rake Trim

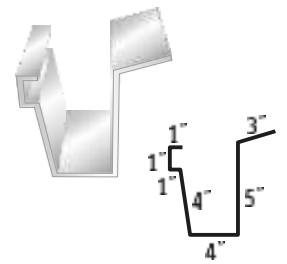

#50 Eave Gutter - Small

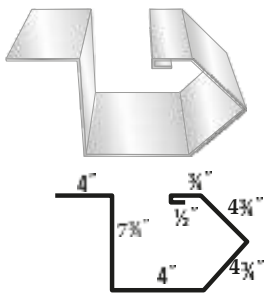

#51 LG Eave Gutter

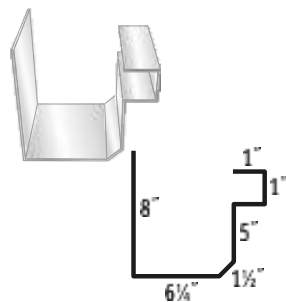

#52 Commercial Gutter

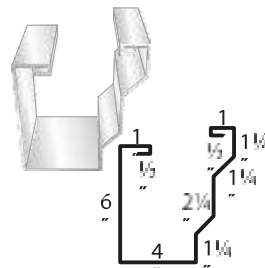

#53 Sculptured Gutter

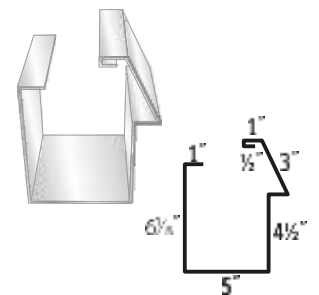

#54 Commercial Gutter

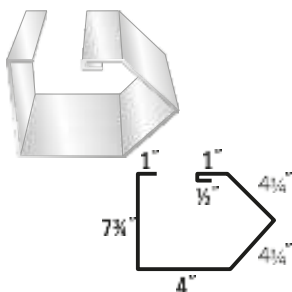

#55 Commercial Gutter

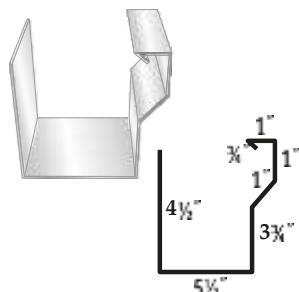

#56 Gutter

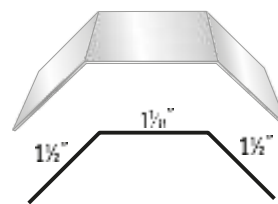

#58 PBR Gutter Hanger

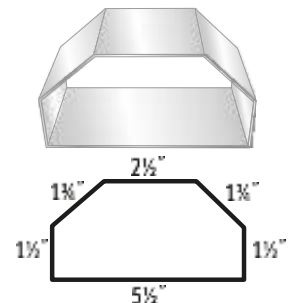

#65 Sculptured Downspout



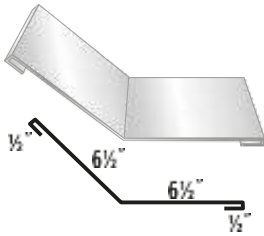

#67 Transition Flashing

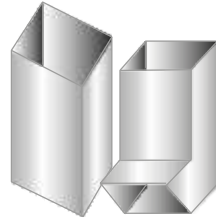

**Downspouts**   **Elbows**  
 #60 4x5     #68 4x5  
 #61 3x5     #69 3x5  
 #62 4x4     #70 4x4  
 #63 3x4     #71 3x4

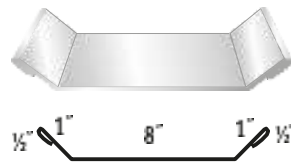

#77 Valley Cover

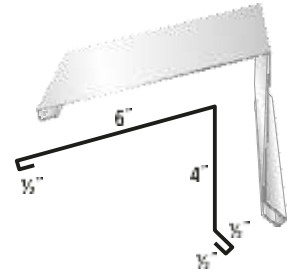

#80 Peak Cap

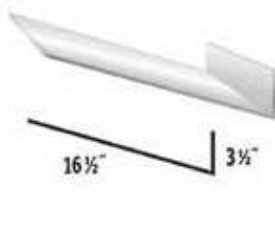

#81 Chimney Flashing

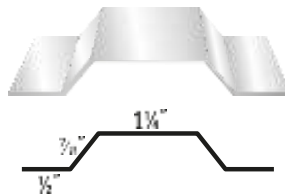

#82 Hat Channel

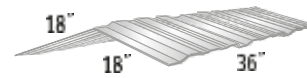

PBR Ridge Cap



# SECONDARY FRAMING



Structural sections are manufactured using ASTM A 1011 grade 50, class 2 (55 KSI minimum yield) with a red oxide finish or ASTM A 653 grade 50, class 2 (55 KSI min yield) with a G90 galvanized finish. Cee or Zee shapes with web depths of 4", 6", 8", 9", and 12" in a variety of symmetrical or unsymmetrical flanges. Special shape single or double slope, high side or low side eave struts are available.

A variety of angles, channels, and hat sections are also available, please inquire.

## CEEs and ZEEs



**Cee**



**LGSI Zee**



**Standard Zee**



**Single Slope**



**Double Slope**



**Universal**

## Eave Struts

## Channels, Hat Sections, and Base Angles



**Channel**



**1-1/2" Channel**



**1-1/4" Hat Section**



**Base Angle**



**1" Sub-girt**

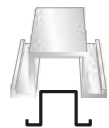

**1-5/8" Hat Section**

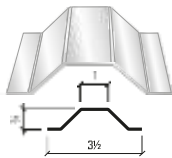

**3/4" Hat Section**  
Length: 12'-3"

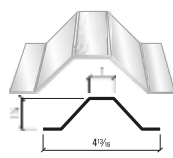

**1-1/4" Hat Section**  
Length: 12'-3"

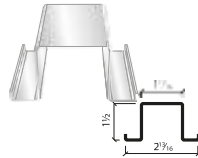

**1-1/2" Hat Section**  
Length: 20'-0"

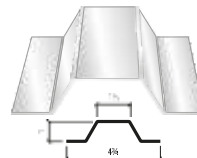

**1" Sub Girt**  
Length: 20'-0"

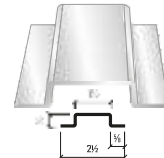

**1/2" Sub Girt**  
Length: 20'-0"



**1-1/2" Channel**  
Length: 20'-0"

**Other components are available. Please inquire.**



# ACCESORIES



# ACCESSORIES

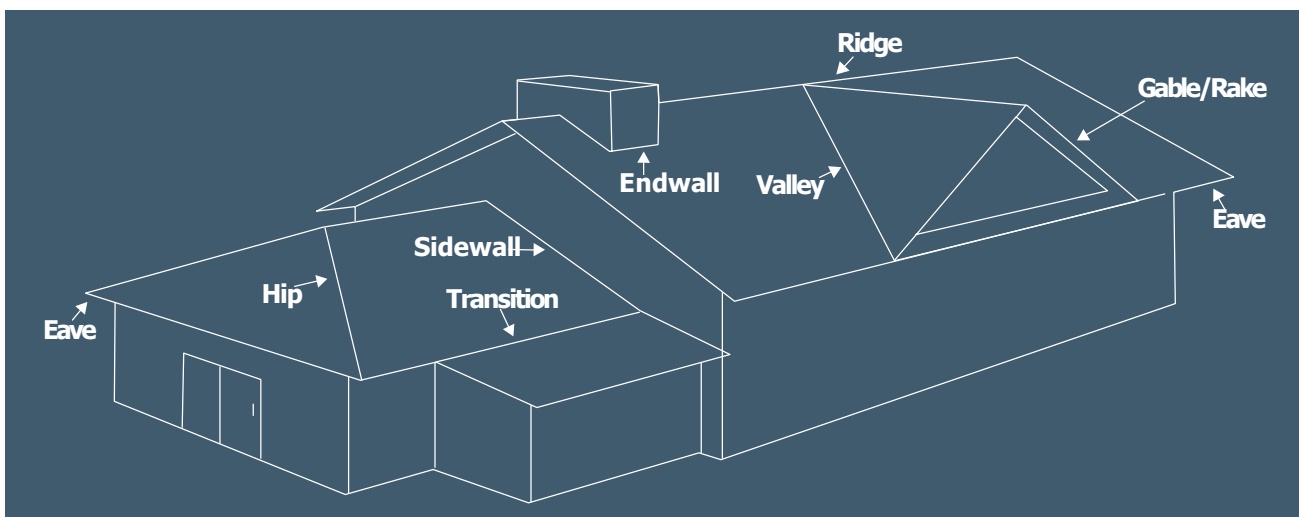
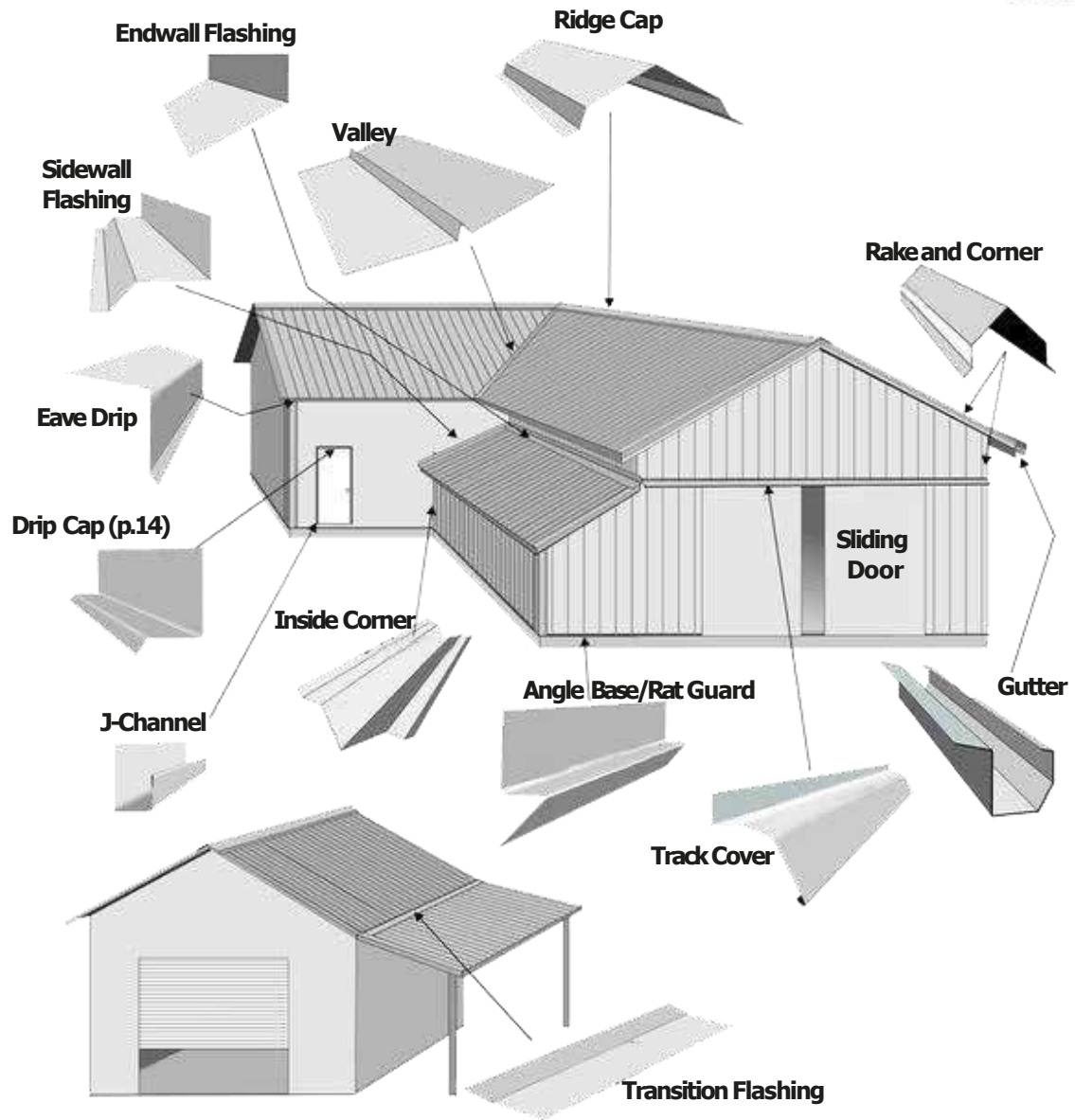

# FASTENER ACCESSORIES



## #10 Woodzip Fastener

Features a thick bonded E.P.D.M washer for weather tight seal

Metal to wood applications

**AVAILABLE IN:** 1", 1-1/2", 2", 2-1/2", 3"

Full DMG85 coating for corrosion resistance

TP-17 point reduces penetration shavings

Packaged 250 pieces per bag

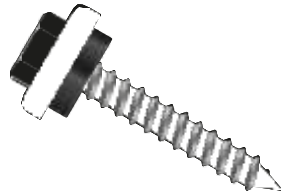

## Premium #12 Warranted Woodscrew

Long life stainless steel with 20 year warranty

Metal to wood applications

**AVAILABLE IN:** 1", 1-1/2", 2", 2-1/2", 3"

Packaged 250 pieces per bag

Large diameter for extra holding power

Available in standard colors to match panels

More back-out resistance than standard #9 diameter fasteners

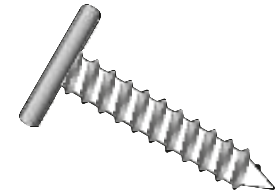

## #12 Pancake XG Type "A"

With flat head for use with standing seam concealed panel applications

More back-out resistance than #10 fasteners

Concealed panel to wood applications

**AVAILABLE IN:** 1", 1-1/2", 2"

Phillips drive

Extra holding power and zinc plating

Packaged 250 pieces or 2,500 pieces per bag



## Premium #12 Warranted Self-Drilling Fasteners

Long life stainless steel with 20 year warranty

Metal to metal applications up to 8 gage

Coated for corrosion resistance

**AVAILABLE IN:** 1", 1-1/4", 1-1/2", 2", 2-1/2", 3", #14 heavy duty

Packaged 250 pieces per bag

Available with self-drill #5 point for installation into metal substrates up to 1/2" thick

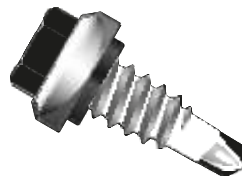

## Premium #14 Warranted Stitch/Lap Fasteners

Long life stainless steel with 20 year warranty

Metal to metal applications up to 8 gage

Metal panel and trim to metal panel applications - 5/16" drive

**AVAILABLE IN:** 7/8" with #1 self- drill point

Packaged 250 pieces per bag

Stitch thread for superior hold

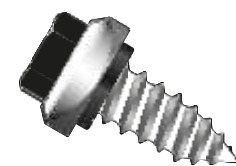

## Premium #14 and #17 Warranted Replacement Fasteners

Long life stainless steel with 20 year warranty

Metal to metal and metal to wood applications

Designed to replace old, worn, and rusted fasteners

3/8" drive

Available in #14 heavy duty

Packaged 250 pieces per bag

**AVAILABLE IN:** #14 x 1", #14 x 1-1/2", #14 x 2", #14 x 2-1/2", #17 x 1", #17 x 1-1/2"

# FASTENER ACCESSORIES



## Premium #43 Stainless Steel Rivets

With full 300 series stainless steel rivet and mandrel

40-year corrosion warranty

For use with aluminum, copper, or Galvalume panels

1/8" rivets with a grip range of 0.126" to 0.187"

Concealed panel and trim applications

Packaged 250 pieces or 5,000 pieces per bag



## WIP 250HT Self-Adhering Roofing Underlayment

Consists of fiberglass-reinforced rubberized asphalt laminated to an impermeable film layer to provide dual-barrier moisture protection

Non-abrasive polyester surface is excellent for use in tile and metal applications.

### AVAILABLE IN:

62 mils thick, 36" x 66.8' rolls (200 ft<sup>2</sup>)



## Geocel 2300 Clear Sealant

Flexible, resists cracking

Easy to apply, paintable

Excellent adhesion to many building substrates - even damp, oily, or dirty

Cured sealant is mildew resistant

### AVAILABLE IN:

10oz tubes (Available in standard metal roof colors by special order)



## Standard Masterflash EPDM Pipe Flashing Round Grey

With 20-year warranty and UV protection

Waterproofs roof penetrations

### AVAILABLE IN:

Various sizes to fit up to 26" pipes Standard #3 fits 1/4" to 4" pipes

Packaged 10 pieces per box



## Premium Colored EPDM Pipe Flashing Square Colored

With 20-year warranty and UV protection

Waterproofs roof penetrations

### AVAILABLE IN:

11 standard colors Standard #3 fits 1/4" to 4" pipes

Packaged 15 pieces per box

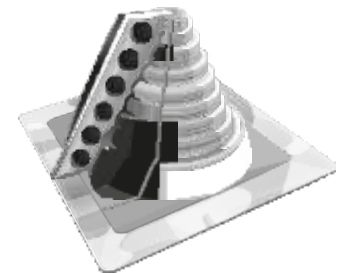

## Standard Retrofit Masterflash EPDM Pipe Flashing

Square Grey

With 20-year warranty and UV protection

Waterproofs collared pipes and electrical conduit

### AVAILABLE IN:

various sizes to fit up to 16-1/4" pipes

Standard #101 fits 1/2" to 4" pipes

Packaged 5 pieces per box

# FASTENER ACCESSORIES



## Premium Tacky Tape Butyl Tape Sealant Rolls

100% solid, asbestos-free butyl tape sealant. Highly rubbery, tacky, reinforced, compound designed for sealing metal lap joints in the metal building industry.

Easy to apply and compress during installation. Excellent application and performance characteristics over a wide temperature range. Will not become brittle, crack, or flow during service.

Supplied in ready-touse rolls and pre-cut endlap pads for standing seam roof (SSR) applications. Also available in double and triple bead rolls and endlap pads.

Seal and prevent the entry of dust, air, and moisture and assure a weather-tight seal in metal building details, metal rib and end joints, standing seam roof endlaps, and more.

### AVAILABLE IN:

3/32" x 3/8" x 45' rolls  
 3/32" x 1/2" x 45' rolls (standard)  
 3/32" x 1" x 45' rolls  
 Double Bead 7/8" rolls and  
 Triple Bead 2-1/2" rolls



## Touch-Up Paint

Aerosol paint designed to match panel colors, for use to touch up minor nicks, scrapes, or scratches which may occur during installation.

### AVAILABLE IN:

4.25oz aerosol cans

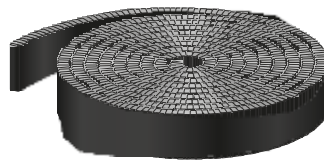

## Razorback Ridge Vent Metal Roofing Ridgevent

Universal to fit many panel profiles

Weatherproofs ridge while providing ventilation

Convenient 10' rolls with adhesive for easy installation

Florida Building Code approved

110MPH wind driven rain resistance

40-year UV resistant

### AVAILABLE IN:

1-1/2" x 2" x 10' rolls  
 (10 rolls/pkg - 100 lft)  
 1-3/4" x 2" x 10' rolls  
 (10 rolls/pkg - 100 lft special order)

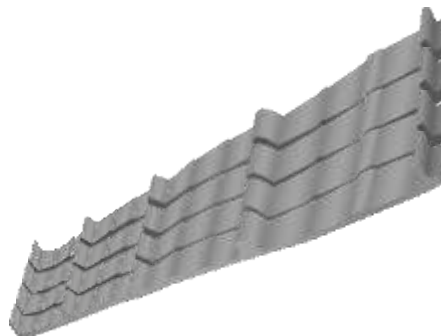

## Standard Closure Strips - Die Cut

Cut to fit specific panel profiles

Inside closures for eave / outside closures for ridge

Weatherproofs panel profiles at the eave and ridge

Available with adhesive for easy installation

### AVAILABLE IN:

100 pieces per box, length of closure strip will equal your panel width



## Direct\*Seal Longlife Universal Closure Rolls

Universal to fit many panel profiles

Convenient 20' rolls with adhesive for easy installation

Seals ends of panel profiles when standard closures cannot be used

Common uses include hips and valleys

40-year UV resistant

### AVAILABLE IN:

1" x 1" x 20' rolls -&t  
 1-1/2" x 1-1/2" x 20' rolls

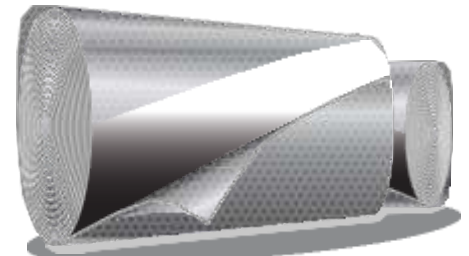

## Bubble Foil Insulation

Reflects 97% of radiant energy, cost efficient, non-toxic, non-carcinogenic, quick and easy installation, cClass A/ Class 1 fire rating, inhibits dew point condensation problems, no protective clothing required for installation, great vapor barrier, does not promote nesting of insects or rodents, does not compress, collapse or disintegrate and is extensively tested.

Single bubble foil white ranges from horizontal value of R5.9 to heat flow down value of R13.2

### AVAILABLE IN:

6' x 125' rolls (750ft2)





## Polycarbonate Translucent Panels

Polycarbonate panels are strong and durable up to 200 times the strength of traditional glass. Polycarbonate Translucent Panels are co-extruded with UV protection. UV Ray resistance with optimal light transmission. Up to 10 year warranty against loss of light transmission due to yellowing, and damage due to hail.

### AVAILABLE IN:

0.031" thick (12' Clear MR9, 12' Clear MR12, 12' Opal/White MR12) -- 0.039" thick (12' Clear MR9, 12' Gray MR12, 12' Opal/White MR12) -- 0.06" thick (12' White MR12)

## Pipe Flashings, Flasher, Dektite, Masterflash, Goosenecks and Retrofit



**Designed for metal roofing to flash in pipe penetrations through panels.**

Pipe opening can be easily customized on job sight utilizing clearly marked pipe diameters on each flashing

EPDM and Silicone are both flexible materials, resistant to ultraviolet rays, cracking, or weathering

Aluminum base is corrosion resistant and conforms easily to any panel configuration of roof pitch

Retrofit flashings are available for electric conduit, or piping, with welded caps or cross bars

**Gooseneck vents sizes available:** 4" x 7", 4" x 10", 10" x 10"; Galvalume or white

### Installation

Ask salesperson for installation instruction sheet.  
Galvalume or white

### INSTOCKSIZES

#### ROUND BASE

Gray EPDM Flasher / Dektite #1, #2, #3, #4, #5, #6, #7, #8, #9  
Retrofit Gray EPDM Dektite (Call about sizes)

#### SQUARE BASE

Gray EPDM Flasher / Masterflash - #3  
Retrofit EPDM Gray Masterflash - #101  
Silicone High Temp Red Masterflash - #3

## SPECIFICATIONS

TESTTYPE	EPDM	SILICONE
Advance ozone resistance test at 500 PPHM	70 HRS	70 HRS
High temperature Intermittent:	275° F	500° F
High temperature Continuous:	212° F	437° F
Low temperature resistance tested to	-65° F	-100° F
Tensile Strength	1450 PSI	700 PSI

## Sizes

SIZE	FITS PIPES	O.D.
#1	1-1/4" - 2"	43/4"
#2	1-3/4" - 3 1/4"	6 1/4"
#3	1/4" - 4"	7 3/4"
#4	3" - 6 1/4"	9 1/4"
#5	4 1/4" - 7 1/2"	10 3/4"
#6	5" - 9"	12 1/4"
#7	6" - 11"	14 1/4"
#8	7" - 13"	14 1/4"
#9	10" - 19"	25 1/4"

## RETROFIT MASTERFLASH

SIZE	FITS PIPES
#101	1/2" - 4"
#201	4" - 9 1/4"
#301	9 1/4" - 16 1/4"



**METAL SUPPLY LLC**

Phone: 813 388 8151

Email: [sales@dxdsupply.com](mailto:sales@dxdsupply.com)

Address: 5002 S. Manhattan Avenue, Tampa  
FL 33616

[www.dxdsupply.com](http://www.dxdsupply.com)